

XGO

TravelPro

▶ WATCH NOW

Scan me on your phone camera to watch our assembly video.



USER MANUAL

PRODUCT CODE: MS04010012

LIFETIME FRAME WARRANTY

INTRODUCING YOUR X-GO TRAVELPRO MOBILITY SCOOTER

The X-GO TravelPro has been designed to provide a comfortable and safe solution for individuals that experience difficulty in walking.

Due to CareCo's commitment to continuous product improvement, product information and designs are subject to change without notice. No claims can be made based on the data and illustrations in this user manual.

The X-GO TravelPro is a Class I Medical Device: Class B Mobility Scooter, limited to a maximum speed of 4MPH.

It is the responsibility of the user and/or attendant to determine if they are mentally and physically capable of using the scooter safely. A risk assessment should be completed by a competent individual before operating the scooter.



CareCo (UK) Limited, 1 Turing Court,
Great Notley, Braintree, CM77 7AT

Tel: 0333 015 5000
www.CareCo.co.uk

Thank you for choosing CareCo.



This manual can be viewed in PDF format at the following URL: **www.careco.co.uk**

FIRST USE

Take the time to understand the scooter's stopping duration, turning radius, throttle sensitivity and manoeuvrability.

Practice using the scooter in an open area until confident enough to operate in smaller and/or public areas.

Operate the scooter at a lower speed before gradually increasing to a higher speed.

If any additional assembly, disassembly and/or operation assistance is required, please contact CareCo.

Keep this user manual in a safe place for future reference.

KEY DEFINITIONS

This user manual contains warnings and suggestions marked with the following symbols:



WARNING! Highlights a potentially hazardous condition/situation for the user and/or product.



SUGGESTION General suggestions and advice for operating the product.

Need help with assembly?

We've put together a step-by-step assembly guide to help you get your product set up safely and correctly. Just scan the QR code with your phone camera to play the video.



CONTENTS

GETTING STARTED _____	6
CARTON CONTENTS	
PRODUCT COMPONENTS	
SETTING UP YOUR X-GO TRAVELPRO MOBILITY SCOOTER	
HOW TO USE YOUR MOBILITY SCOOTER _____	10
USER INSTRUCTIONS	
BRAKING TYPES	
TILLER CONTROLS	
ARMRESTS	
SEAT	
MOBILITY SCOOTER MODES	
EMERGENCY BRAKING	
YOUR MOBILITY SCOOTER BATTERY _____	17
BATTERY INSTALLATION & REMOVAL	
BATTERY INFORMATION	
AUTOMATED POWER-SAVING	
CHARGING YOUR MOBILITY SCOOTER _____	18
HOW TO CHARGE YOUR SCOOTER BATTERY (ON-SCOOTER)	
HOW TO CHARGE YOUR SCOOTER BATTERY (OFF-SCOOTER)	
CHARGING REGIME	
CHARGING INFORMATION	
FOLDING YOUR SCOOTER, TRANSPORTATION & STORAGE _____	20
FOLDING INSTRUCTIONS	
TRANSPORTATION	
STORING THE SCOOTER	
COMFORT ADJUSTMENTS _____	23
TILLER ANGLE ADJUSTMENT	

PERSONALISATION	24
REPLACING THE SHROUDS	
OPTIONAL EXTRAS	25
X-GO TRAVELPRO AIRLINE BATTERY PACK	
X-GO TRAVELPRO TRAVEL BAG	
X-GO TRAVELPRO MULTI-FUNCTION ACCESSORY	
ESSENTIAL HARD CASE	
LOOKING AFTER YOUR MOBILITY SCOOTER	27
PRELIMINARY CHECKS	
CLEANING	
MAINTENANCE	
MAINTENANCE SCHEDULE	
REPAIRS	
TROUBLESHOOTING	29
WARNINGS & TECHNICAL INFORMATION	31
SPECIFICATIONS	
ELECTROMAGNETIC INTERFERENCE (EMI)	
PROGRAMMING	
PRODUCT RE-ISSUING	
RECYCLING & DISPOSAL	
INTENDED USE	
INTENDED USER	
INTENDED ENVIRONMENT	
PRODUCT IDENTIFICATION	
DEFINITIONS	
GENERAL WARNINGS	
EXPECTED LIFETIME	34
WARRANTY	35

GETTING STARTED

CARTON CONTENTS

ITEM NUMBER	DESCRIPTION	QUANTITY
1	X-GO TravelPro Mobility Scooter	1
2	Seat w/ Armrests	1
3	Battery Pack	1
4	Battery Charger	1
5	Key	2
6	Cup Holder Assembly	1
7	Green Shroud Set	1
8	Purple Shroud Set	1

Contact CareCo immediately if any of the listed contents are missing.

We strongly recommend that you keep the box and internal packaging for the duration of your warranty period.

PRODUCT COMPONENTS



1. Tiller Control Panel
2. Bottle Holder
3. Seat
4. Armrests
5. Seat Folding Mechanism
6. Carry Handle
7. Front Wheel
8. Rear Wheel
9. Front Light
10. Basket
11. Battery

SETTING UP YOUR X-GO TRAVELPRO MOBILITY SCOOTER



1. Remove all scooter components from the outer packaging and place them onto a level surface.

2. Hold the tiller handles, then press & hold the yellow adjustment lever to adjust the tiller height.

Release the lever when the tiller is at the desired height.



3. Remove the controller cover thumbscrews to reveal the controller.

4. Install the 35A Fuse, then reinstall the controller cover.



5. Lift the seat bracket upwards.
An audible “click” will confirm the seat bracket is secure.



6. Lift the yellow seat lever whilst lowering the seat onto the seat bracket.
Release the yellow seat lever to secure the position.



7. Lift the seat backrest and armrests upwards.



8. Install the cup holder using the Allen key & fixings provided.



9. Place the basket onto the basket bracket.

10. Charge the scooter for 12 hours before first use.



SUGGESTION Subsequent charging times range from 6-8 hours. Visit “CHARGING YOUR MOBILITY SCOOTER” for more information.

HOW TO USE YOUR MOBILITY SCOOTER

USER INSTRUCTIONS

TRANSFERRING TO & FROM

Always ensure the scooter is switched [OFF] and in [DRIVE] mode before getting on/off the scooter.

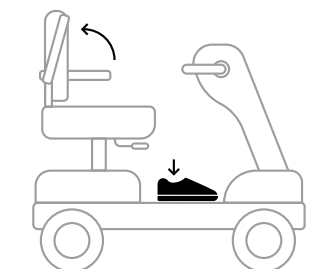

Transfer to

Lift the scooter armrest(s) upwards.

Support your body by placing one foot on the scooter footplate before lowering into the seat.

Lower the armrest into its resting position.

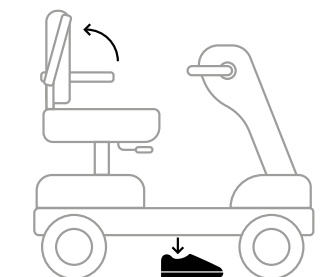

Transfer from

Lift the scooter armrest(s) upwards.

Support your body by placing one foot on the ground before pushing upwards to lift out of the seat.

Lower the armrest into its resting position.

GRADIENTS



Ascending Gradients

Tilt your upper body forward when travelling up gradients for increased stability.



Descending Gradients

Tilt your upper body back when travelling down gradients for increased stability.

The maximum safe slope of incline is 6°.

THRESHOLDS & FIXED OBSTACLES

Approach thresholds vertically to avoid scooter misbalance.

Correct Approach

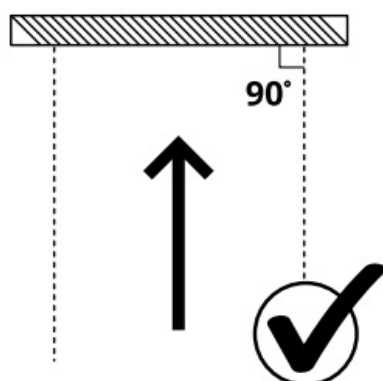

Incorrect Approach

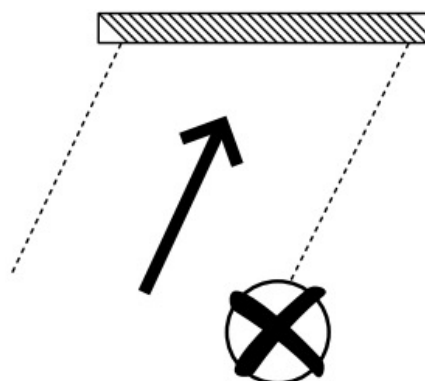

STAIRS, ESCALATORS AND LIFTS

The mobility scooter is not designed to travel up/down stairs and escalators. Use a lift whenever possible.

DOORS & GATES

Determine whether the door/gate opens towards or away from the user.

Reach for the handle and carefully accelerate forwards or backwards depending on the door/gate orientation.

CORNERING

Approach corners at a speed that the user feels comfortable and in control of. If at any point the user feels like the scooter may tip, reduce the scooter speed and steering angle.

BRAKING TYPES

REGENERATIVE BRAKING

- Slows the scooter when the throttle returns to the centre position.
- Slows the scooter when the speed limiter is exceeded.

PARKING BRAKE

- Activates after the scooter has come to a stop.
- Activates when the scooter is in [DRIVE] mode and is switched [OFF]

BRAKING DISTANCE

On flat surfaces, braking distance is approximately equal to the length of the scooter. Braking distance may increase when travelling downhill.

TILLER CONTROLS



KEY SWITCH

Insert the key and rotate clockwise to activate the scooter.

BATTERY GAUGE

Displays the battery level status.

GREEN

The battery is fully charged.

YELLOW

The battery is at half capacity.

RED

The battery is low and should be charged soon.

SPEED DIAL

Turn anti-clockwise to increase the scooter's speed setting. (Towards the Hare icon).

Turn clockwise to decrease the scooter's speed setting. (Towards the tortoise icon).

HEADLIGHT SWITCH

Push (-) to activate the front & rear lights.

Push (o) to deactivate the front & rear lights.

THROTTLE LEVER

Using your right hand, press the throttle lever to move the scooter forwards.

Using your left hand, press the throttle lever to move the scooter backwards.

When the lever is released, it will return to the centre and the scooter brake will automatically engage

HORN BUTTON

Push to sound the horn.

CHARGING SOCKET

Insert the charger to charge the scooter's battery.



TILLER ADJUSTMENT LEVER

Raise or lower the tiller to the desired position.



USB PORT (1AMP)

Insert USB powered accessories and devices

ARMRESTS



FOLDING UPWARDS

Lift the armrest(s) upwards to assist the user when transferring.



FOLDING DOWNWARDS

Pull the armrest(s) outwards then push downwards to assist the user when transporting the scooter and its components.

SEAT

ATTACHING

1. Lift the yellow lever whilst lowering the seat onto the seat bracket.
2. Release the yellow lever to secure the position.



REMOVING

Lift the yellow lever whilst pulling the seat upwards.



SUGGESTION Fold the seat backrest & armrests to assist the user when attaching or removing the seat.

MOBILITY SCOOTER MODES



DRIVE MODE

(ELECTRONIC ASSISTED BRAKING)

Push the switch backwards to engage Drive Mode.

(The scooter will not be able to be pushed manually).



FREEWHEEL MODE

Push the switch forwards to engage Freewheel Mode.

(The scooter will be able to be pushed manually).

! **WARNING!** Do not change the scooters mode whilst on an incline.

💡 **SUGGESTION** Switching [ON] the scooter whilst in freewheel mode will activate the scooters automatic warning function.

EMERGENCY BRAKING

Switch [OFF] the power while moving to immediately stop the scooter.

! **WARNING!** This method is for emergency situations only.

Repeated use of the [ON/OFF] switch to stop the scooter may shorten the life of the scooter's components.

YOUR MOBILITY SCOOTER BATTERY

BATTERY INSTALLATION & REMOVAL



INSTALLING

1. Place the battery pack into the battery tray.
2. Push downwards on the front of the battery pack to secure in place.

REMOVING

1. Push the battery release button.
2. Lift the battery pack away from the scooter.

BATTERY INFORMATION

BATTERY TYPE	LITHIUM BATTERY
SPILLABLE/NON-SPILLABLE	NON-SPILLABLE
VOLTAGE	24V
AMPAGE	15AH
QUANTITY	1
WATT HOURS	360Wh



WARNING! Ensure the scooter is switched [OFF] before installing or removing the battery.

AUTOMATED POWER-SAVING

When the scooter is switched [OFF], the freewheeling function will automatically deactivate after 5 minutes of inactivity to reserve battery charge.

To reactivate the freewheeling function:

Push the switch backwards to engage Drive Mode

Push the switch forwards to engage Freewheel Mode.

CHARGING YOUR MOBILITY SCOOTER

Your X-GO Travel Pro battery can be charged on, or away from the scooter.

HOW TO CHARGE YOUR SCOOTER BATTERY (ON-SCOOTER)

1. Insert the charger's 3-pin output into the socket on the underside of the tiller panel.
2. Insert the outlet plug into a wall socket.
3. Switch [ON] the wall socket.
4. Charge for 6-8 hours.



When charging is completed, remove the charger from the scooter socket and remove the plug from the wall outlet.



SUGGESTION Ensure the scooter is switched [OFF] before charging.

HOW TO CHARGE YOUR SCOOTER BATTERY (OFF-SCOOTER)

1. Push the battery release button.
2. Lift the battery pack away from the scooter.
3. Insert the charger's 3-pin output into the socket on the battery.
4. Insert the outlet plug into a wall socket.
5. Switch [ON] the wall socket.
6. Charge for 6-8 hours.



When charging is completed, remove the charger from the battery and remove the plug from the wall outlet.

CHARGING REGIME

Maintaining good charging habits for your mobility scooter will maximize battery life and range per charge.

Battery charging times range from 6-8 hours. This is dependent on scooter usage, ambient temperature, and operating habits.

Daily Use If the scooter is used daily, charge the battery daily for 6-8 hours.

Weekly Use If the scooter is used once or twice a week, charge the battery for at least 6-8 hours once a week.

Monthly Use If the scooter is stored for long periods of time, charge the battery for 6-8 hours once every two weeks to preserve the life of the battery.

CHARGER INFORMATION

The battery charger is fitted with a smart LED indicator that indicates when the battery is charging and when charging is complete.

LED Indicator **Charging Status**

 **GREEN** **Charged**

 **RED** **Charging**



WARNING! Do not use the supplied charger with any other electrical device.

Only charge the scooter with the supplied charger or an official replacement.

Do not leave the scooter on charge indefinitely.



SUGGESTION Charge the battery in a cool, dry place with plenty of ventilation.

FOLDING YOUR SCOOTER, TRANSPORTATION AND STORAGE

FOLDING INSTRUCTIONS

Your X-GO TravelPro can be folded to make transportation and storage easier.

⚠ WARNING! Ensure the scooter is switched [OFF] and in [DRIVE] Mode before folding.



1. Lift the basket away from the basket bracket.



2. Fold down the backrest and armrests.



3. Lift the yellow seat lever whilst pulling the seat away from the scooter.



(Optional) Remove the battery from the scooter.



4. Pull the spring-loaded knobs on either side of the seat bracket, then push the seat bracket downwards



5. Press & hold the tiller adjustment lever, then fold the tiller downwards.



(Optional) Place the seat onto the tiller fixture to secure it to the scooter.

TRANSPORTATION

CARRYING

Fold the scooter, then carry it from the footplate carry handle.

PULLING ALONG

Fold the scooter, then lift it by the tiller carry handle.

Push or pull the scooter along on its anti-tipper wheels.



SUGGESTION Lift from areas that are clear from pinching points to avoid scooter damage and personal injury.

LAND TRANSPORT

Securely stow the folded/disassembled components in the boot of a vehicle.

Ensure any adjustable parts are properly secured before transport to avoid transit damage.



WARNING! This product cannot be used as a seat in a motor vehicle.



AIR TRANSPORT

This scooter can be transported by air with the additional 10AH airline safe battery pack. Contact CareCo for more information.

STORING THE SCOOTER

SHORT TERM STORAGE

Store the scooter in a cool and dry environment. Do not store in extreme temperatures.

LONG TERM STORAGE

Fully charge the battery before long term storage.

Store the scooter in a cool and dry environment. Do not store in extreme temperatures.

Charge the battery once every two weeks to preserve the life of the battery.

STORAGE TEMPERATURE

-20°C to 40°C

 **WARNING!** Storing the scooter in extreme temperatures can cause premature rusting & damage to the scooters electronic system.

COMFORT ADJUSTMENTS

TILLER ANGLE ADJUSTMENT

1. Hold the tiller handles, then press & hold the yellow adjustment lever.
2. Pivot the tiller to a comfortable position, then release the tiller adjustment lever.



 **WARNING!** The X-GO TravelPro tiller is operated by a gas strut. Take extra care when adjusting the tiller position.

PERSONALISATION

REPLACING THE SHROUDS

Your X-GO TravelPro arrives with two additional shroud packs in the box to personalise your scooter.

REMOVING THE SHROUD

Pry the shroud away from the scooter.

ATTACHING THE SHROUD

Push the shroud into position.

Ensure the shroud is secure before use.



OPTIONAL EXTRAS

X-GO TRAVELPRO AIRLINE BATTERY PACK

This scooter can be transported by air with the additional 10AH airline battery pack.

Contact CareCo for more information.



X-GO TRAVELPRO TRAVEL BAG

Keep your X-GO TravelPro safe whilst on the move with the additional travel bag.

Contact CareCo for more information.



X-GO TRAVELPRO MULTI-FUNCTION ACCESSORY

Add additional features and benefits to your scooter with the multi-function accessory.



ESSENTIAL HARD CASE

Keep belongings safe and secure with the essential hard case.



LOOKING AFTER YOUR MOBILITY SCOOTER

PRELIMINARY CHECKS

- Ensure the scooter is switched [OFF] before getting off or on.
- Ensure the scooter is in [DRIVE] mode before setting off.
- Check tyres for wear.
- Check all fixings are secure.

CLEANING

Regular use of the scooter will accumulate dirt and debris over time.

Clean the scooter using mild soap and warm water, then dry using a cloth.



WARNING! Do not use bleach or strong chemicals to clean the scooter.

Ensure the scooter is off and disconnected from the mains prior to cleaning.



SUGGESTION Regular cleaning & maintenance can help prolong the scooters lifespan.

MAINTENANCE

The scooter is made up of components which over time will become susceptible to wear and tear.

Knowing how to properly care and maintain your scooter will not only ensure peak performance and safe operation but will also help maintain operation for years to come.

MAINTENANCE SCHEDULE

Carry out regular inspections to keep the scooter in optimum condition.

COMPONENT	INSPECTION DESCRIPTION	AT ANY TIME	WEEKLY	MONTHLY	QUARTERLY
TILLER CONTROLS	Ensure the tiller controls function as intended.	○			
DRIVE/BRAKE SYSTEM	Ensure the scooter moves normally and the brake is responsive.	○			
CONNECTIONS	Ensure the scooter connections are free from damage and corrosion.	○			
BATTERY	Ensure the battery and any relevant connections are free from damage and corrosion.				○
TYRES	Ensure tyres have sufficient tread and are in a good condition.				○
FRAMEWORK	Ensure the framework is clear from debris, damage, and folds without issue.	○			
FASTENERS	Ensure all fasteners are tight and components are not loose.				○
WHEELS	Ensure the wheels are aligned and drive straight.				○
UPHOLSTERY	Check for wear and tear.		○		
OVERALL	Overall check for wear and residue build-up. Cleaning if required			○	

REPAIRS

Certain scooter components can be repaired by the user with guidance provided by CareCo.

Other components can only be repaired/replaced by a service technician.

If for any reason the scooter requires repair due to a defect, contact CareCo immediately.

TROUBLESHOOTING

The scooter features an automatic fault warning function.

If there is an internal issue with the scooter, the battery indicator will flash, and the horn will sound.

FLASH CODE	POSSIBLE CAUSE	POSSIBLE REMEDY
1 FLASH / BEEP	The battery voltage is too low.	Charge the battery for 6-8 hours.
2 FLASH / BEEP	The motor and/or its associated wiring has a fault.	Check for any loose connections and tighten if required.
		Contact CareCo.
3 FLASH / BEEP	The motor and/or its associated wiring has a fault.	Contact CareCo.
4 FLASH / BEEP	The scooter is in [FREEWHEEL] mode.	1. Switch [OFF] the scooter 2. Place the scooter in [DRIVE] mode. 3. Switch [ON] the scooter
	The brake and/or its associated wiring has a fault.	Contact CareCo.
5 FLASH / BEEP	The scooter is in [FREEWHEEL] mode.	1. Switch [OFF] the scooter 2. Place the scooter in [DRIVE] mode. 3. Switch [ON] the scooter
	The brake and/or its associated wiring has a fault.	Contact CareCo.
6 FLASH / BEEP	The charger is connected to the scooter.	1. Switch [OFF] the scooter 2. Disconnect the charger 3. Switch [ON] the scooter.
7 FLASH / BEEP	The throttle lever is being obstructed.	1. Switch [OFF] the scooter 2. Release the throttle lever obstruction 3. Switch [ON] the scooter
	The throttle and/or its associated wiring has a fault	Contact CareCo.
	The speed potentiometer and/ or its associated wiring has a fault	Contact CareCo.
8 FLASH / BEEP	The controller and/or its associated wiring has a fault.	
9 FLASH / BEEP	The scooter is in [FREEWHEEL] mode.	1. Switch [OFF] the scooter 2. Place the scooter in [DRIVE] mode. 3. Switch [ON] the scooter
	The brake and/or its associated wiring has a fault.	Contact CareCo.
10 FLASH / BEEP	The controller and/or its associated wiring has a fault.	Check for any loose connections and tighten if required.
		Contact CareCo.

TROUBLESHOOTING (NO FLASH CODE)

The scooter may not operate as intended due to a fuse fault undetectable by the automatic fault warning function. Check the fuse(s) and replace if required.

35A BLADE FUSE



3A GLASS FUSE



FAULT	POSSIBLE CAUSE	POSSIBLE REMEDY
The tiller display and headlight/taillight do not illuminate when the scooter is switched [ON].	The 35A controller fuse has blown.	Replace the 35A fuse.
The USB charging port does not work.		
The tiller charging port does not function.	The 3AMP glass fuse has blown.	Replace the 3AMP glass fuse.

⚠ WARNING! Replace the fuse with the same type and rating. Ensure the scooter is switched [OFF] when replacing a fuse.

WARNINGS & TECHNICAL INFORMATION

SPECIFICATIONS

OVERALL LENGTH (MM)	965.2
OVERALL WIDTH (MM)	495.3
OVERALL HEIGHT (MM)	876.3
FOLDED LENGTH (MM)	965.2
FOLDED WIDTH (MM)	495.3
FOLDED HEIGHT (MM)	304.8
FRONT WHEEL DIAMETER (IN)	6
REAR WHEEL DIAMETER (IN)	7
TOTAL WEIGHT INCLUDING BATTERIES (KG)	29.71
WEIGHT OF HEAVIEST COMPONENT (KG)	21.54
MAXIMUM SPEED (MPH)	4
MAXIMUM REVERSE SPEED (MPH)	2
REVERSING WIDTH (MM)	1900
WEIGHT CAPACITY (KG)*	136
GROUND CLEARANCE (MM)	101.6
MAXIMUM CLIMBABLE ANGLE (°)	6°
MAXIMUM CURB HEIGHT CLIMBABLE (MM)	25
TURNING RADIUS (°)	48.75
SEAT WIDTH (MM)	381
SEAT WEIGHT (KG)	5.44
BATTERY SPECIFICATION	24v 15ah
MOTOR SPECIFICATION	DC24V 120W 4800rpm
BATTERY WEIGHT (KG)	2.7
MAXIMUM POTENTIAL RANGE (KM)	28
STOPPING DISTANCE FROM MAX SPEED (MM)	1500
MAX/MIN OPERATING TEMPERATURE (°C)	40°C to -20°C
MAX/MIN STORAGE TEMPERATURE (°C)	40°C to -20°C
SUITABLE FOR AIR TRANSPORT	Yes with Airsafe 10AH battery
TYRE TYPE	Solid
EXPECTED SERVICE LIFE (YEARS)	10

*The maximum weight limit for this product includes both the user and any other accessories fitted to the scooter.

ELECTROMAGNETIC INTERFERENCE (EMI)

Powerchairs and mobility scooters may be susceptible to electromagnetic interference (EMI).

Electromagnetic energy (EM) is emitted from sources such as radio stations, TV stations, amateur radio (HAM) transmitters, two-way radios, and cellular phones.

The interference (from radio wave sources) can cause the powerchair/mobility scooter to release its brakes, move by itself, or move in unintended directions. It can also permanently damage the powerchair/mobility scooter's control system.

Each powerchair/mobility scooter can resist EMI up to certain intensity. The intensity of the interfering EM energy can be measured in volts per meter (V/m).

If the scooter is operating abnormally, turn off the scooter and/or the equipment that is believed to be causing the interference.



WARNING! Do not operate portable personal communication devices, such as citizen band (CB) radios and mobile phones when the scooter is powered [ON].

If use of a personal communication device is required, ensure the scooter operates as intended.

Avoid using the scooter near transmitters, such as radio or television stations.

Adding unauthorised accessories, parts, or modification can make the scooter more susceptible to interference from radio wave sources.

The immunity level of this mobility scooter is 20 V/m.

PROGRAMMING

The scooter can be programmed using computer-based software and/or using a handheld programming device.

Programming should only be completed by a qualified service technician. Unauthorised modifications will affect driving performance and other parameters.

PRODUCT RE-ISSUING

Ensure the scooter is safe and functions as intended before re-issuing

RECYCLING & DISPOSAL

Scooter components should not be disposed of with normal household waste as they can cause harm to the environment.

When disposing of the scooter and/or its components, users should follow Waste Electrical and Electronic Equipment policies (W.E.E.E).

For battery disposal, users should follow local disposal/recycling regulations.

Contact CareCo if further advice is needed regarding recycling & disposal.

INTENDED USE

This product is intended for users who experience difficulty in walking and/or have reduced mobility.

INTENDED USER

To aid a user with mobility limitations to move around independently and safely.

INTENDED ENVIRONMENT







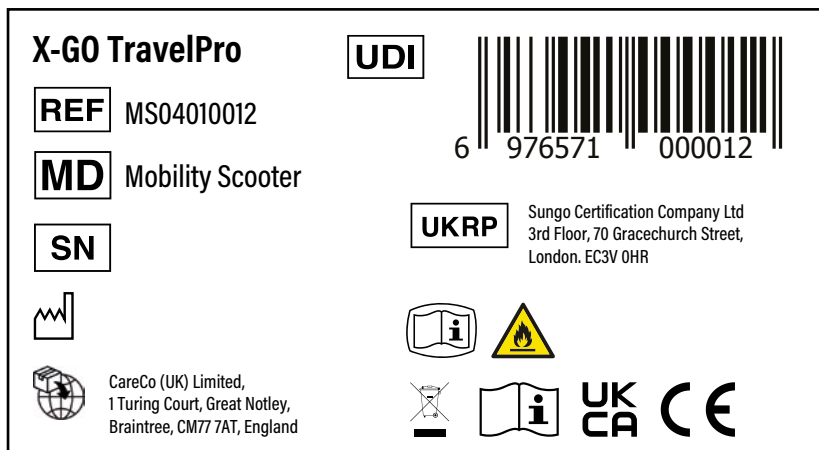





This scooter is designed to be used both indoors and outdoors on firm, level ground. Take care when using the scooter in inclement weather conditions.

PRODUCT IDENTIFICATION

The product identification label is located underneath the battery.



DEFINITIONS

	Model number		Refer to instruction manual
	Batch code		Caution
	Date of manufacturer		Indicates electrical / electronic equipment must be disposed of in accordance with the WEEE regulation.
	Manufacturer's address		Keep away from rain
	Product expiry date		Keep away from sunlight
	UK responsible person		
	UKCA Mark		
	Non sterile		

GENERAL WARNINGS

- Mobility Scooter users should take appropriate safety measures and obey local pedestrian traffic rules. CareCo are not responsible for personal injury and/or product damage caused by improper use.
- Use safety equipment such as reflectors, reflective clothing, and lighting when in low lit areas.
- Please consult a healthcare professional regularly to ensure that there are no health/physical conditions that limit or compromise the user's safety when using the scooter.
- If the user is taking over-the-counter medications, prescriptions or if physical activity is limited, please consult a physician. Some medications and medical conditions may limit the user's ability to operate the scooter.
- Do not operate the scooter after consuming alcohol as this can affect the safe operation of the scooter.
- Do not use the scooter for any other purpose other than its intended use. Incorrect use of the scooter can cause a safety hazard to the product and the user.
- This scooter is intended for one user at a time. Do not exceed the maximum load weight of 136kg.
- Do not place the scooter in manual mode when on an incline.
- Turn the scooter [OFF] when sat in a fixed position for extended periods of time.
- Avoid using accessories that could interfere with the safe operation of the throttle.
- Do not alter the products wiring.
- Prolonged exposure to hot and cold environments may damage the scooter's upholstery and electrical components.
- Keep body, clothing, and any other objects away from moving parts to avoid trap hazards.
- Do not use the scooter to tow another item.
- Prolonged storage at low or high temperatures can damage the scooter.
- Do not transport the scooter or battery with combustible materials.
- This product cannot be used as a seat in a motor vehicle. 
- Ensure the scooter is in Drive mode before operating.
- Be aware of surroundings at all times when using the scooter.

EXPECTED LIFETIME

The Expected Lifetime is the estimated period of time for which the scooter is expected to function according to its intended use.

Various items such as weight capacity, user behaviour, external conditions and intensity of use can affect the expected lifetime.

WEIGHT CAPACITY:

If the user exceeds the weight limit specified, it may affect the scooter's expected lifetime.

USER BEHAVIOUR:

Using excessive force, rough handling or dropping components can significantly shorten the scooter's expected lifetime.

EXTERNAL CONDITIONS:

Extreme temperatures, humidity and exposure to harsh weather conditions can accelerate the deterioration of the scooter.

USAGE:

A scooter that is used daily may experience more wear and tear compared to a scooter that is used occasionally.

The expected lifetime for the scooter is 10 years providing the instructions and information within this user manual are followed.

Regular cleaning, lubrication of moving parts, and tightening of loose fixings will prevent premature wear and damage and extend the product's lifetime.

The expected lifetime is not related to the product warranty.

WARRANTY

If a component requires repair or replacement due to a specific manufacturing or material defect within its warranty period, it will be repaired or replaced free of charge by CareCo.

SCOOTER FRAME: LIFETIME WARRANTY

Your X-GO TravelPro metal framework is covered by a lifetime warranty from the date of purchase. The following components will be repaired or replaced if found to be defective:

- Metal Body Framework
- Metal Tiller Framework
- Seat Post
- Frame Welds

ELECTRONIC COMPONENTS: 1-YEAR LIMITED WARRANTY

BATTERY: 6-MONTH LIMITED WARRANTY

Consumables are not covered under normal warranty circumstances unless they have clearly suffered excessive wear or damage as a direct result of a manufacturing defect. These items include grips, tyres, and rubber accessories. The guarantee for the scooter is not transferable.

Parts that have been previously replaced that require subsequent repair or replacement due to manufacturing defects will be honoured for the remainder of the scooter's warranty period.

Parts that have been purchased by the end user after the original warranty period has expired have a warranty period of 12 months.

CareCo is not responsible if the scooter requires repair or replacement as a direct result of:

- Changes or modifications made to the product that fall outside of the manufacturer's specifications.
- The product not being serviced or maintained according to the manufacturer's recommendations contained in this user manual.
- Negligence, Accidental Damage, and Improper use.
- Repairs attempted before CareCo have been notified.
- The product being purposely damaged or mistreated.

In the unlikely event that this product is recalled, CareCo will notify the user.

Please ensure that your contact information is up to date.

Alternatively, please visit our website for any product alerts: www.CareCo.co.uk

XGO **TravelPro**

CareCo



CareCo (UK) Limited, 1 Turing Court,
Great Notely, Braintree, CM77 7AT, England



MOBILITY SCOOTER

